

Features

- Spread spectrum for EMI reduction
 - Wide spread % option
 - Center spread: from $\pm 0.125\%$ to $\pm 2\%$, $\pm 0.125\%$ step size
 - Down spread: -0.25% to -4% with -0.25% step size
 - Spread profile option: Triangular, Hershey-kiss
- Programmable rise/fall time for EMI reduction: 8 options, 0.25 to 40 ns
- Any frequency between 1 MHz and 141 MHz accurate to 6 decimal places
- 100% pin-to-pin drop-in replacement to quartz-based XO's
- Excellent total frequency stability as low as ± 20 ppm
- Operating temperature from -40°C to 85°C
- Low power consumption of 4.0 mA typical at 1.8 V
- Pin1 modes: Standby, output enable, or spread disable
- Fast startup time of 5 ms
- LVCMOS output
- Industry-standard packages
 - QFN: 2.0×1.6 , 2.5×2.0 , 3.2×2.5 mm²
 - [Contact SiTime](#) for SOT23-5 (2.9×2.8 mm²)
- RoHS and REACH compliant, Pb-free, Halogen-free and Antimony-free

Applications

- Surveillance camera
- IP camera
- Industrial motors
- Flat panels
- Multi function printers
- PCI express



Electrical Specifications

Table 1. Electrical Characteristics

All Min and Max limits are specified over temperature and rated operating voltage with 15 pF output load unless otherwise stated. Typical values are at 25°C and 3.3 V supply voltage.

Parameters	Symbol	Min.	Typ.	Max.	Unit	Condition
Frequency Range						
Output Frequency Range	f	1	–	141	MHz	
Frequency Stability and Aging						
Frequency Stability	F_stab	-20	–	+20	ppm	Inclusive of initial tolerance at 25°C , 1st year aging at 25°C , and variations over operating temperature, rated power supply voltage. Spread = Off.
		-25	–	+25	ppm	
		-50	–	+50	ppm	
Operating Temperature Range						
Operating Temperature Range	T_use	-20	–	+70	$^{\circ}\text{C}$	Extended Commercial
		-40	–	+85	$^{\circ}\text{C}$	Industrial
Supply Voltage and Current Consumption						
Supply Voltage	Vdd	1.62	1.8	1.98	V	
		2.25	2.5	2.75	V	
		2.52	2.8	3.08	V	
		2.7	3.0	3.3	V	
		2.97	3.3	3.63	V	
		2.25	–	3.63	V	
Current Consumption	Idd	–	5.6	6.5	mA	No load condition, f = 40 MHz, Vdd = 2.5 V to 3.3 V
		–	5.0	5.5	mA	No load condition, f = 40 MHz, Vdd = 1.8 V
OE Disable Current	I_OD	–	5.0	6.5	mA	f = 40 MHz, Vdd = 2.5 V to 3.3 V, OE = GND, Output in high-Z state
		–	4.6	5.2	mA	f = 40 MHz, Vdd = 1.8 V, OE = GND, Output in high-Z state
Standby Current	I_std	–	2.1	4.3	μA	$\overline{\text{ST}}$ = GND, Vdd = 2.5 V to 3.3 V, Output is weakly pulled down
		–	0.4	1.5	μA	$\overline{\text{ST}}$ = GND, Vdd = 1.8 V, Output is weakly pulled down

Table 1. Electrical Characteristics (continued)

Parameters	Symbol	Min.	Typ.	Max.	Unit	Condition
LVC MOS Output Characteristics						
Duty Cycle	DC	45	–	55	%	
Rise/Fall Time	Tr, Tf	–	1	2	ns	Vdd = 2.5 V, 2.8 V, 3.0 V or 3.3 V, 20% - 80%, default derive strength
		–	1.3	2.5	ns	Vdd = 1.8 V, 20% - 80%, default derive strength
		–	–	2	ns	Vdd = 2.25 V - 3.63 V, 20% - 80%, default derive strength
Output High Voltage	VOH	90%	–	–	Vdd	IOH = -4 mA (Vdd = 3.0 V or 3.3 V) IOH = -3 mA (Vdd = 2.8 V and Vdd = 2.5 V) IOH = -2 mA (Vdd = 1.8 V)
Output Low Voltage	VOL	–	–	10%	Vdd	IOL = 4 mA (Vdd = 3.0 V or 3.3 V) IOL = 3 mA (Vdd = 2.8 V and Vdd = 2.5 V) IOL = 2 mA (Vdd = 1.8 V)
Input Characteristics						
Input High Voltage	VIH	70%	–	–	Vdd	Pin 1, OE or \overline{ST}
Input Low Voltage	VIL	–	–	30%	Vdd	Pin 1, OE or \overline{ST}
Input Pull-up Impedance	Z_in	50	87	150	k Ω	Pin 1, OE logic high or logic low, or \overline{ST} logic high
		2	–	–	M Ω	Pin 1, \overline{ST} logic low
Startup and Resume Timing						
Startup Time	T_start	–	–	5	ms	Measured from the time Vdd reaches its rated minimum value
Enable/Disable Time	T_oe	–	–	180	ns	f = 40 MHz. For other frequencies, T_oe = 100 ns + 3 * cycles
Resume Time	T_resume	–	–	5	ms	Measured from the time ST pin crosses 50% threshold
Spread Enable Time	T_sde	–	–	4	μ s	Measured from the time SD pin crosses 50% threshold
Spread Disable Time	T_sdde	–	–	50	μ s	Measured from the time SD pin crosses 50% threshold
Jitter						
Cycle-to-cycle jitter	T_ccj	–	10.5	15	ps	f = 40 MHz, Vdd = 2.5 to 3.3V, Spread = ON(or OFF)
		–	8.5	12	ps	f = 40 MHz, Vdd = 3.3V, Spread = ON(or OFF)
		–	12.5	22	ps	f = 40 MHz, Vdd = 1.8V, Spread = ON(or OFF)

Table 2. Spread Spectrum % [1,2]

Ordering Code	Center Spread (%)	Down Spread (%)
A	±0.125	-0.25
B	±0.250	-0.50
C	±0.390	-0.78
D	±0.515	-1.04
E	±0.640	-1.29
F	±0.765	-1.55
G	±0.905	-1.84
H	±1.030	-2.10
I	±1.155	-2.36
J	±1.280	-2.62
K	±1.420	-2.91
L	±1.545	-3.18
M	±1.670	-3.45
N	±1.795	-3.71
O	±1.935	-4.01
P	±2.060	-4.28

Notes:

- In both center spread and down spread modes, modulation rate is employed with a frequency of ~31.25 kHz.
- Contact SiTime for wider spread options

Table 3. Spread Profile

Spread Profile
Triangular
Hershey-kiss

Table 4. Pin Description

Pin	Symbol		Functionality
1	OE/ $\overline{\text{ST}}$ / NC/SD	Output Enable	H ^[3] : specified frequency output L: output is high impedance. Only output driver is disabled.
		Standby	H ^[3] : specified frequency output L: output is low (weak pull down). Device goes to sleep mode. Supply current reduced to I _{std} .
		No Connect	Pin1 has no function (Any voltage between 0 and Vdd or Open)
		Spread Disable	H: Spread = ON L: Spread = OFF
2	GND	Power	Electrical ground
3	OUT	Output	Oscillator output
4	VDD	Power	Power supply voltage ^[4]

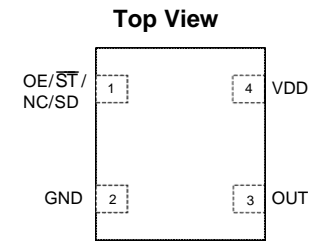

Figure 1. Pin Assignments

Notes:

- In OE or $\overline{\text{ST}}$ mode, a pull-up resistor of 10 k Ω or less is recommended if pin 1 is not externally driven. If pin 1 needs to be left floating, use the NC option.
- A capacitor of value 0.1 μF or higher between Vdd and GND is required.

Table 5. Absolute Maximum Limits

Attempted operation outside the absolute maximum ratings may cause permanent damage to the part. Actual performance of the IC is only guaranteed within the operational specifications, not at absolute maximum ratings.

Parameter	Min.	Max.	Unit
Storage Temperature	-65	150	$^{\circ}\text{C}$
Vdd	-0.5	4	V
Electrostatic Discharge	–	2000	V
Soldering Temperature (follow standard Pb free soldering guidelines)	–	260	$^{\circ}\text{C}$
Junction Temperature ^[5]	–	150	$^{\circ}\text{C}$

Note:

- Exceeding this temperature for extended period of time may damage the device.

Table 6. Maximum Operating Junction Temperature^[6]

Max Operating Temperature (ambient)	Maximum Operating Junction Temperature
70 $^{\circ}\text{C}$	80 $^{\circ}\text{C}$
85 $^{\circ}\text{C}$	95 $^{\circ}\text{C}$

Note:

- Datasheet specifications are not guaranteed if junction temperature exceeds the maximum operating junction temperature.

Table 7. Environmental Compliance

Parameter	Condition/Test Method
Mechanical Shock	MIL-STD-883F, Method 2002
Mechanical Vibration	MIL-STD-883F, Method 2007
Temperature Cycle	JESD22, Method A104
Solderability	MIL-STD-883F, Method 2003
Moisture Sensitivity Level	MSL1 @ 260 $^{\circ}\text{C}$

Timing Diagrams

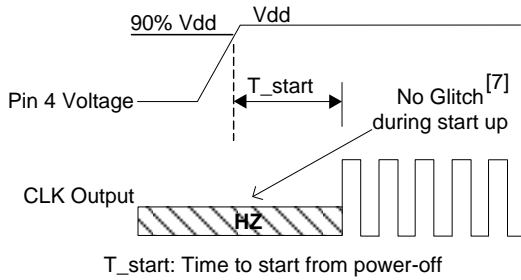

Figure 2. Startup Timing

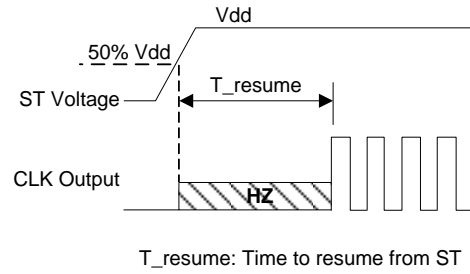

Figure 3. Standby Resume Timing (ST Mode Only)

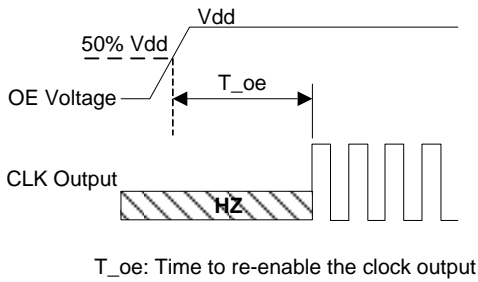

Figure 4. OE Enable Timing (OE Mode Only)

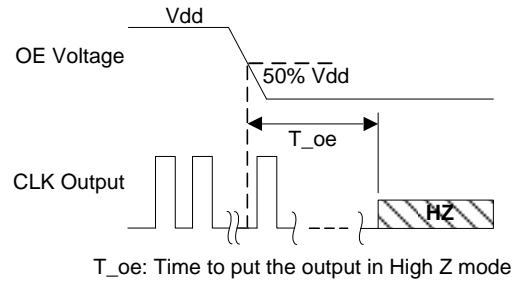

Figure 5. OE Disable Timing (OE Mode Only)

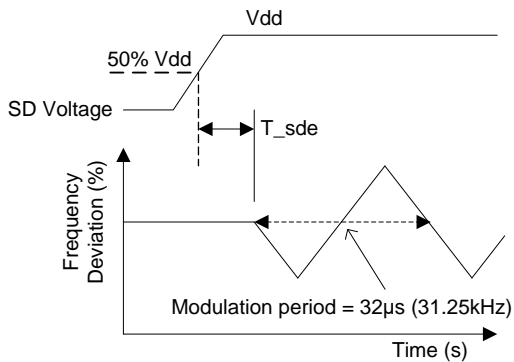

Figure 6. SD Enable Timing (SD Mode Only)

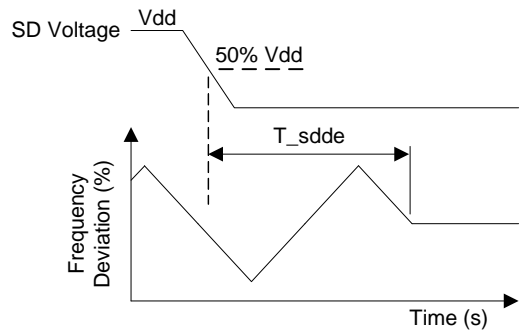

Figure 7. SD Diable Timing (SD Mode Only)

Note:

7. SiT9005 has “no runt” pulses and “no glitch” output during startup or resume.

Programmable Drive Strength

The SiT9005 includes a programmable drive strength feature to provide a simple, flexible tool to optimize the clock rise/fall time for specific applications. Benefits from the programmable drive strength feature are:

- Improves system radiated electromagnetic interference (EMI) by slowing down the clock rise/fall time
- Improves the downstream clock receiver's (RX) jitter by decreasing (speeding up) the clock rise/fall time.
- Ability to drive large capacitive loads while maintaining full swing with sharp edge rates.

For more detailed information about rise/fall time control and drive strength selection, see the [SiTime Application Notes section](#).

EMI Reduction by Slowing Rise/Fall Time

Figure 8 shows the harmonic power reduction as the rise/fall times are increased (slowed down). The rise/fall times are expressed as a ratio of the clock period. For the ratio of 0.05, the signal is very close to a square wave. For the ratio of 0.45, the rise/fall times are very close to near-triangular waveform. These results, for example, show that the 11th clock harmonic can be reduced by 35 dB if the rise/fall edge is increased from 5% of the period to 45% of the period.

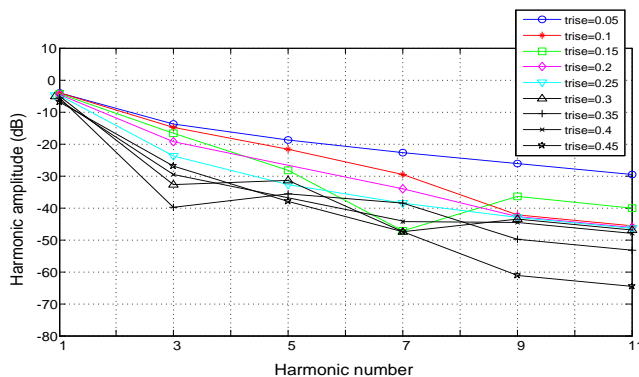

Figure 8. Harmonic EMI reduction as a Function of Slower Rise/Fall Time

Jitter Reduction with Faster Rise/Fall Time

Power supply noise can be a source of jitter for the downstream chipset. One way to reduce this jitter is to increase rise/fall time (edge rate) of the input clock. Some chipsets would require faster rise/fall time in order to reduce their sensitivity to this type of jitter. The SiT9005 provides up to 3 additional high drive strength settings for very fast rise/fall time. Refer to [Table 8](#) through [Table 12](#) to determine the proper drive strength.

High Output Load Capability

The rise/fall time of the input clock varies as a function of the actual capacitive load the clock drives. At any given drive strength, the rise/fall time becomes slower as the output load increases. As an example, for a 3.3V SiT9005 device with default drive strength setting, the typical rise/fall time is 1.1 ns for 15 pF output load. The typical rise/fall time slows down to 2.9 ns when the output load increases to 45 pF. One can choose to speed up the rise/fall time to 1.9 ns by then increasing the drive strength setting on the SiT9005.

The SiT9005 can support up to 60 pF or higher in maximum capacitive loads with up to 3 additional drive strength settings. Refer to [Table 8](#) through [Table 12](#) to determine the proper drive strength for the desired combination of output load vs. rise/fall time

SiT9005 Drive Strength Selection

Table 8 through Table 12 define the rise/fall time for a given capacitive load and supply voltage.

1. Select the table that matches the SiT9005 nominal supply voltage (1.8 V, 2.5 V, 2.8 V, 3.3 V).
2. Select the capacitive load column that matches the application requirement (15 pF to 60 pF)
3. Under the capacitive load column, select the desired rise/fall times.
4. The left-most column represents the part number code for the corresponding drive strength.
5. Add the drive strength code to the part number for ordering purposes.

Calculating Maximum Frequency

Based on the rise and fall time data given in [Table 8](#) through [Table 12](#), the maximum frequency the oscillator can operate with guaranteed full swing of the output voltage over temperature as follows:

$$\text{Max Frequency} = \frac{1}{5 \times \text{Trf}_{20/80}}$$

where Trf_{20/80} is the typical rise/fall time at 20% to 80% V_{dd}

Example 1

Calculate f_{MAX} for the following condition:

- V_{dd} = 3.3 V ([Table 12](#))
- Capacitive Load: 30 pF
- Desired Tr/f time = 1.6 ns (rise/fall time part number code = Z)

Part number for the above example:

SiT9005AIZ14-33EB-105.12345

↑
Drive strength code is inserted here. Default setting is “-”

Rise/Fall Time (20% to 80%) vs C_{LOAD} Tables

Table 8. V_{dd} = 1.8 V Rise/Fall Times for Specific C_{LOAD}

Rise/Fall Time Typ (ns)					
Drive Strength \ C _{LOAD}	5 pF	15 pF	30 pF	45 pF	60 pF
L	6.16	11.61	22.00	31.27	39.91
A	3.19	6.35	11.00	16.01	21.52
R	2.11	4.31	7.65	10.77	14.47
B	1.65	3.23	5.79	8.18	11.08
T	0.93	1.91	3.32	4.66	6.48
E	0.78	1.66	2.94	4.09	5.74
U	0.70	1.48	2.64	3.68	5.09
F or "-": default	0.65	1.30	2.40	3.35	4.56

Table 9. V_{dd} = 2.5 V Rise/Fall Times for Specific C_{LOAD}

Rise/Fall Time Typ (ns)					
Drive Strength \ C _{LOAD}	5 pF	15 pF	30 pF	45 pF	60 pF
L	4.13	8.25	12.82	21.45	27.79
A	2.11	4.27	7.64	11.20	14.49
R	1.45	2.81	5.16	7.65	9.88
B	1.09	2.20	3.88	5.86	7.57
T	0.62	1.28	2.27	3.51	4.45
E or "-": default	0.54	1.00	2.01	3.10	4.01
U	0.43	0.96	1.81	2.79	3.65
F	0.34	0.88	1.64	2.54	3.32

Table 10. V_{dd} = 2.8 V Rise/Fall Times for Specific C_{LOAD}

Rise/Fall Time Typ (ns)					
Drive Strength \ C _{LOAD}	5 pF	15 pF	30 pF	45 pF	60 pF
L	3.77	7.54	12.28	19.57	25.27
A	1.94	3.90	7.03	10.24	13.34
R	1.29	2.57	4.72	7.01	9.06
B	0.97	2.00	3.54	5.43	6.93
T	0.55	1.12	2.08	3.22	4.08
E or "-": default	0.44	1.00	1.83	2.82	3.67
U	0.34	0.88	1.64	2.52	3.30
F	0.29	0.81	1.48	2.29	2.99

Table 11. V_{dd} = 3.0 V Rise/Fall Times for Specific C_{LOAD}

Rise/Fall Time Typ (ns)					
Drive Strength \ C _{LOAD}	5 pF	15 pF	30 pF	45 pF	60 pF
L	3.60	7.21	11.97	18.74	24.30
A	1.84	3.71	6.72	9.86	12.68
R	1.22	2.46	4.54	6.76	8.62
B	0.89	1.92	3.39	5.20	6.64
T or "-": default	0.51	1.00	1.97	3.07	3.90
E	0.38	0.92	1.72	2.71	3.51
U	0.30	0.83	1.55	2.40	3.13
F	0.27	0.76	1.39	2.16	2.85

Table 12. V_{dd} = 3.3 V Rise/Fall Times for Specific C_{LOAD}

Rise/Fall Time Typ (ns)					
Drive Strength \ C _{LOAD}	5 pF	15 pF	30 pF	45 pF	60 pF
L	3.39	6.88	11.63	17.56	23.59
A	1.74	3.50	6.38	8.98	12.19
R	1.16	2.33	4.29	6.04	8.34
B	0.81	1.82	3.22	4.52	6.33
T or "-": default	0.46	1.00	1.86	2.60	3.84
E	0.33	0.87	1.64	2.30	3.35
U	0.28	0.79	1.46	2.05	2.93
F	0.25	0.72	1.31	1.83	2.61

Dimensions and Patterns

Package Size – Dimensions (Unit: mm) ^[8]	Recommended Land Pattern (Unit: mm) ^[9]																																																																																																																																																
<p>2.0 x 1.6 x 0.75 mm</p> <p>(TOP VIEW) (BOTTOM VIEW) (SIDE VIEW)</p> <table border="1" style="width:100%; border-collapse: collapse; margin-top: 10px;"> <thead> <tr> <th></th> <th>SYMBOL</th> <th>MIN</th> <th>NOM</th> <th>MAX</th> </tr> </thead> <tbody> <tr> <td>PACKAGE THICKNESS</td> <td>A</td> <td>0.700</td> <td>0.750</td> <td>0.800</td> </tr> <tr> <td>STAND OFF</td> <td>A1</td> <td>0.000</td> <td>0.020</td> <td>0.050</td> </tr> <tr> <td rowspan="2">BODY SIZE</td> <td>X</td> <td colspan="3">D 1,600 BSC</td> </tr> <tr> <td>Y</td> <td colspan="3">E 2,000 BSC</td> </tr> <tr> <td rowspan="2">LEAD WIDTH</td> <td>b</td> <td>0.430</td> <td>0.480</td> <td>0.530</td> </tr> <tr> <td>b1</td> <td>0.230</td> <td>0.280</td> <td>0.330</td> </tr> <tr> <td rowspan="2">LEAD LENGTH</td> <td>L</td> <td>0.580</td> <td>0.680</td> <td>0.780</td> </tr> <tr> <td>L1</td> <td colspan="3">0.100 REF</td> </tr> <tr> <td>LEAD PITCH</td> <td>e</td> <td colspan="3">0.930 BSC</td> </tr> <tr> <td>RADIUS</td> <td>F</td> <td colspan="3">0.100 REF</td> </tr> <tr> <td>PACKAGE TOLERANCE</td> <td>aaa</td> <td colspan="3">0.050</td> </tr> <tr> <td>MOLD FLATNESS</td> <td>bbb</td> <td colspan="3">0.100</td> </tr> <tr> <td>COPLANARITY</td> <td>ccc</td> <td colspan="3">0.080</td> </tr> </tbody> </table> <p>NOTES 1. Dimensioning and tolerance conform to ASME Y14.5-2009 2. All dimensions are in millimeters.</p> <div style="text-align: right; margin-top: 10px;"> </div> <table border="1" style="width:100%; border-collapse: collapse; margin-top: 10px;"> <tr> <td colspan="2" style="text-align: center;">SiTime</td> </tr> <tr> <td>TITLE</td> <td>4L PQFN</td> </tr> <tr> <td>DWG. NO.</td> <td>POD-PQFN-004-X01620-026</td> </tr> <tr> <td>REV.</td> <td>SHEET</td> </tr> <tr> <td>DATE</td> <td>01-APR-2019</td> </tr> <tr> <td></td> <td>A02 1 OF 2</td> </tr> </table>		SYMBOL	MIN	NOM	MAX	PACKAGE THICKNESS	A	0.700	0.750	0.800	STAND OFF	A1	0.000	0.020	0.050	BODY SIZE	X	D 1,600 BSC			Y	E 2,000 BSC			LEAD WIDTH	b	0.430	0.480	0.530	b1	0.230	0.280	0.330	LEAD LENGTH	L	0.580	0.680	0.780	L1	0.100 REF			LEAD PITCH	e	0.930 BSC			RADIUS	F	0.100 REF			PACKAGE TOLERANCE	aaa	0.050			MOLD FLATNESS	bbb	0.100			COPLANARITY	ccc	0.080			SiTime		TITLE	4L PQFN	DWG. NO.	POD-PQFN-004-X01620-026	REV.	SHEET	DATE	01-APR-2019		A02 1 OF 2	<p>2.5 x 2.0 x 0.75 mm</p> <p>(TOP VIEW) (BOTTOM VIEW) (SIDE VIEW)</p> <table border="1" style="width:100%; border-collapse: collapse; margin-top: 10px;"> <thead> <tr> <th></th> <th>SYMBOL</th> <th>MIN</th> <th>NOM</th> <th>MAX</th> </tr> </thead> <tbody> <tr> <td>PACKAGE THICKNESS</td> <td>A</td> <td>0.700</td> <td>0.750</td> <td>0.800</td> </tr> <tr> <td>THICKNESS</td> <td>A1</td> <td>0.000</td> <td>0.020</td> <td>0.050</td> </tr> <tr> <td rowspan="2">BODY SIZE</td> <td>X</td> <td colspan="3">D 2,000 BSC</td> </tr> <tr> <td>Y</td> <td colspan="3">E 2,500 BSC</td> </tr> <tr> <td rowspan="2">LEAD WIDTH</td> <td>b</td> <td>0.300</td> <td>0.350</td> <td>0.400</td> </tr> <tr> <td>L</td> <td>0.650</td> <td>0.750</td> <td>0.850</td> </tr> <tr> <td>LEAD PITCH</td> <td>e</td> <td colspan="3">1.250 BSC</td> </tr> <tr> <td>PACKAGE TOLERANCE</td> <td>aaa</td> <td colspan="3">0.050</td> </tr> <tr> <td>MOLD FLATNESS</td> <td>bbb</td> <td colspan="3">0.100</td> </tr> <tr> <td>COPLANARITY</td> <td>ccc</td> <td colspan="3">0.080</td> </tr> </tbody> </table> <p>NOTES 1. Dimensioning and tolerance conform to ASME Y14.5-2009 2. All dimensions are in millimeters.</p> <div style="text-align: right; margin-top: 10px;"> </div> <table border="1" style="width:100%; border-collapse: collapse; margin-top: 10px;"> <tr> <td colspan="2" style="text-align: center;">SiTime</td> </tr> <tr> <td>TITLE</td> <td>4L PQFN</td> </tr> <tr> <td>DWG. NO.</td> <td>POD-PQFN-004-X02025-010</td> </tr> <tr> <td>REV.</td> <td>SHEET</td> </tr> <tr> <td>DATE</td> <td>01-APR-2019</td> </tr> <tr> <td></td> <td>A02 1 OF 2</td> </tr> </table>		SYMBOL	MIN	NOM	MAX	PACKAGE THICKNESS	A	0.700	0.750	0.800	THICKNESS	A1	0.000	0.020	0.050	BODY SIZE	X	D 2,000 BSC			Y	E 2,500 BSC			LEAD WIDTH	b	0.300	0.350	0.400	L	0.650	0.750	0.850	LEAD PITCH	e	1.250 BSC			PACKAGE TOLERANCE	aaa	0.050			MOLD FLATNESS	bbb	0.100			COPLANARITY	ccc	0.080			SiTime		TITLE	4L PQFN	DWG. NO.	POD-PQFN-004-X02025-010	REV.	SHEET	DATE	01-APR-2019		A02 1 OF 2
	SYMBOL	MIN	NOM	MAX																																																																																																																																													
PACKAGE THICKNESS	A	0.700	0.750	0.800																																																																																																																																													
STAND OFF	A1	0.000	0.020	0.050																																																																																																																																													
BODY SIZE	X	D 1,600 BSC																																																																																																																																															
	Y	E 2,000 BSC																																																																																																																																															
LEAD WIDTH	b	0.430	0.480	0.530																																																																																																																																													
	b1	0.230	0.280	0.330																																																																																																																																													
LEAD LENGTH	L	0.580	0.680	0.780																																																																																																																																													
	L1	0.100 REF																																																																																																																																															
LEAD PITCH	e	0.930 BSC																																																																																																																																															
RADIUS	F	0.100 REF																																																																																																																																															
PACKAGE TOLERANCE	aaa	0.050																																																																																																																																															
MOLD FLATNESS	bbb	0.100																																																																																																																																															
COPLANARITY	ccc	0.080																																																																																																																																															
SiTime																																																																																																																																																	
TITLE	4L PQFN																																																																																																																																																
DWG. NO.	POD-PQFN-004-X01620-026																																																																																																																																																
REV.	SHEET																																																																																																																																																
DATE	01-APR-2019																																																																																																																																																
	A02 1 OF 2																																																																																																																																																
	SYMBOL	MIN	NOM	MAX																																																																																																																																													
PACKAGE THICKNESS	A	0.700	0.750	0.800																																																																																																																																													
THICKNESS	A1	0.000	0.020	0.050																																																																																																																																													
BODY SIZE	X	D 2,000 BSC																																																																																																																																															
	Y	E 2,500 BSC																																																																																																																																															
LEAD WIDTH	b	0.300	0.350	0.400																																																																																																																																													
	L	0.650	0.750	0.850																																																																																																																																													
LEAD PITCH	e	1.250 BSC																																																																																																																																															
PACKAGE TOLERANCE	aaa	0.050																																																																																																																																															
MOLD FLATNESS	bbb	0.100																																																																																																																																															
COPLANARITY	ccc	0.080																																																																																																																																															
SiTime																																																																																																																																																	
TITLE	4L PQFN																																																																																																																																																
DWG. NO.	POD-PQFN-004-X02025-010																																																																																																																																																
REV.	SHEET																																																																																																																																																
DATE	01-APR-2019																																																																																																																																																
	A02 1 OF 2																																																																																																																																																

Dimensions and Patterns (continued)

Package Size – Dimensions (Unit: mm) ^[8]	Recommended Land Pattern (Unit: mm) ^[9]																																																																		
<p>3.2 x 2.5 x 0.75 mm</p> <p>(TOP VIEW) (BOTTOM VIEW) (SIDE VIEW)</p> <table border="1" style="width:100%; border-collapse: collapse; margin-top: 10px;"> <thead> <tr> <th></th> <th>SYMBOL</th> <th>MIN</th> <th>NOM</th> <th>MAX</th> </tr> </thead> <tbody> <tr> <td>PACKAGE THICKNESS</td> <td>A</td> <td>0.700</td> <td>0.750</td> <td>0.800</td> </tr> <tr> <td>STAND OFF</td> <td>A1</td> <td>0.000</td> <td>0.020</td> <td>0.050</td> </tr> <tr> <td rowspan="2">BODY SIZE</td> <td>X</td> <td colspan="3">D 2.500 BSC</td> </tr> <tr> <td>Y</td> <td colspan="3">E 3.200 BSC</td> </tr> <tr> <td rowspan="2">LEAD WIDTH</td> <td>b</td> <td>0.800</td> <td>0.900</td> <td>1.000</td> </tr> <tr> <td>L</td> <td>0.700</td> <td>0.800</td> <td>0.900</td> </tr> <tr> <td rowspan="2">LEAD LENGTH</td> <td>L1</td> <td>0.100</td> <td>REF</td> <td></td> </tr> <tr> <td>e</td> <td>2.100</td> <td>BSC</td> <td></td> </tr> <tr> <td rowspan="2">RADIUS</td> <td>F</td> <td>0.450</td> <td>REF</td> <td></td> </tr> <tr> <td>F1</td> <td>0.120</td> <td>REF</td> <td></td> </tr> <tr> <td>PACKAGE TOLERANCE</td> <td>aaa</td> <td colspan="3">0.050</td> </tr> <tr> <td>MOLD FLATNESS</td> <td>bbb</td> <td colspan="3">0.100</td> </tr> <tr> <td>COPLANARITY</td> <td>ccc</td> <td colspan="3">0.080</td> </tr> </tbody> </table> <p>NOTES 1. Dimensioning and tolerance conform to ASME Y14.5-2009 2. All dimensions are in millimeters.</p> <div style="text-align: right; margin-top: 10px;"> </div>		SYMBOL	MIN	NOM	MAX	PACKAGE THICKNESS	A	0.700	0.750	0.800	STAND OFF	A1	0.000	0.020	0.050	BODY SIZE	X	D 2.500 BSC			Y	E 3.200 BSC			LEAD WIDTH	b	0.800	0.900	1.000	L	0.700	0.800	0.900	LEAD LENGTH	L1	0.100	REF		e	2.100	BSC		RADIUS	F	0.450	REF		F1	0.120	REF		PACKAGE TOLERANCE	aaa	0.050			MOLD FLATNESS	bbb	0.100			COPLANARITY	ccc	0.080			
	SYMBOL	MIN	NOM	MAX																																																															
PACKAGE THICKNESS	A	0.700	0.750	0.800																																																															
STAND OFF	A1	0.000	0.020	0.050																																																															
BODY SIZE	X	D 2.500 BSC																																																																	
	Y	E 3.200 BSC																																																																	
LEAD WIDTH	b	0.800	0.900	1.000																																																															
	L	0.700	0.800	0.900																																																															
LEAD LENGTH	L1	0.100	REF																																																																
	e	2.100	BSC																																																																
RADIUS	F	0.450	REF																																																																
	F1	0.120	REF																																																																
PACKAGE TOLERANCE	aaa	0.050																																																																	
MOLD FLATNESS	bbb	0.100																																																																	
COPLANARITY	ccc	0.080																																																																	
<table border="1" style="width:100%; border-collapse: collapse;"> <tr> <td>TITLE</td> <td>4L PQFN</td> <td>DWG NO.</td> <td>POD-PQFN-004-X03225-002</td> </tr> <tr> <td></td> <td>3.20x2.50x0.75 mm</td> <td>REV.</td> <td>SHEET</td> </tr> <tr> <td>DATE</td> <td>01-APR-2019</td> <td>A04</td> <td>1 OF 2</td> </tr> </table>		TITLE	4L PQFN	DWG NO.	POD-PQFN-004-X03225-002		3.20x2.50x0.75 mm	REV.	SHEET	DATE	01-APR-2019	A04	1 OF 2																																																						
TITLE	4L PQFN	DWG NO.	POD-PQFN-004-X03225-002																																																																
	3.20x2.50x0.75 mm	REV.	SHEET																																																																
DATE	01-APR-2019	A04	1 OF 2																																																																

Notes:

8. Top marking: Y denotes manufacturing origin and XXXX denotes manufacturing lot number. The value of “Y” will depend on the assembly location of the device.
9. A capacitor of value 0.1 μ F or higher between Vdd and GND is required.

Ordering Information

The Part No. Guide is for reference only.

To customize and build an exact part number, use the SiTime [Part Number Generator](#).

SiT9005AI-71-18EA25.000625D

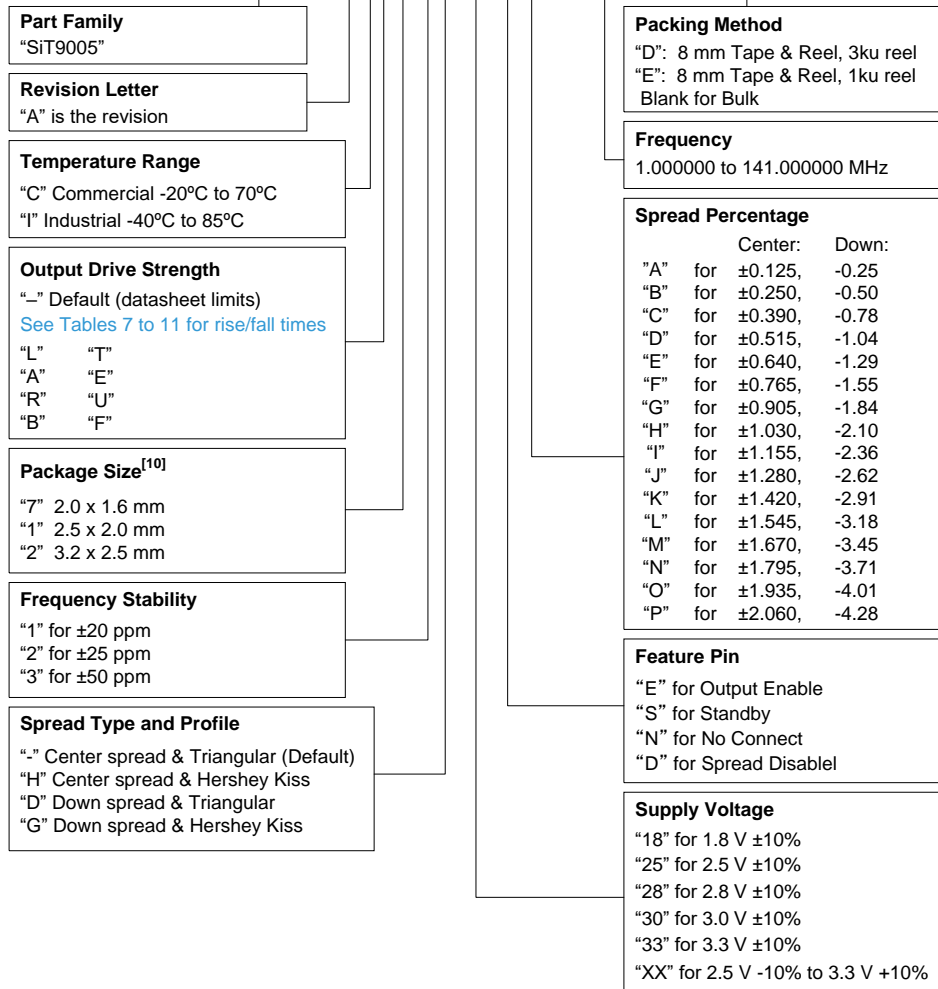

Note:

10. [Contact SiTime](#) for SOT23 (2.9 x 2.8 mm²) package.

Table 13. Revision History

Revision	Release Date	Change Summary
1.0	25-Sep-2017	Final release
1.01	11-Mar-2021	Formatting layout issues, updated hyperlinks and changed rev table date format Updated Dimensions and Patterns drawings

SiTime Corporation, 5451 Patrick Henry Drive, Santa Clara, CA 95054, USA | Phone: +1-408-328-4400 | Fax: +1-408-328-4439

© SiTime Corporation 2017-2021. The information contained herein is subject to change at any time without notice. SiTime assumes no responsibility or liability for any loss, damage or defect of a Product which is caused in whole or in part by (i) use of any circuitry other than circuitry embodied in a SiTime product, (ii) misuse or abuse including static discharge, neglect or accident, (iii) unauthorized modification or repairs which have been soldered or altered during assembly and are not capable of being tested by SiTime under its normal test conditions, or (iv) improper installation, storage, handling, warehousing or transportation, or (v) being subjected to unusual physical, thermal, or electrical stress.

Disclaimer: SiTime makes no warranty of any kind, express or implied, with regard to this material, and specifically disclaims any and all express or implied warranties, either in fact or by operation of law, statutory or otherwise, including the implied warranties of merchantability and fitness for use or a particular purpose, and any implied warranty arising from course of dealing or usage of trade, as well as any common-law duties relating to accuracy or lack of negligence, with respect to this material, any SiTime product and any product documentation. Products sold by SiTime are not suitable or intended to be used in a life support application or component, to operate nuclear facilities, or in other mission critical applications where human life may be involved or at stake. All sales are made conditioned upon compliance with the critical uses policy set forth below.

CRITICAL USE EXCLUSION POLICY

BUYER AGREES NOT TO USE SITIME'S PRODUCTS FOR ANY APPLICATION OR IN ANY COMPONENTS USED IN LIFE SUPPORT DEVICES OR TO OPERATE NUCLEAR FACILITIES OR FOR USE IN OTHER MISSION-CRITICAL APPLICATIONS OR COMPONENTS WHERE HUMAN LIFE OR PROPERTY MAY BE AT STAKE.

SiTime owns all rights, title and interest to the intellectual property related to SiTime's products, including any software, firmware, copyright, patent, or trademark. The sale of SiTime products does not convey or imply any license under patent or other rights. SiTime retains the copyright and trademark rights in all documents, catalogs and plans supplied pursuant to or ancillary to the sale of products or services by SiTime. Unless otherwise agreed to in writing by SiTime, any reproduction, modification, translation, compilation, or representation of this material shall be strictly prohibited.